

Model No. DVR450 CORDLESS CONCRETE VIBRATOR

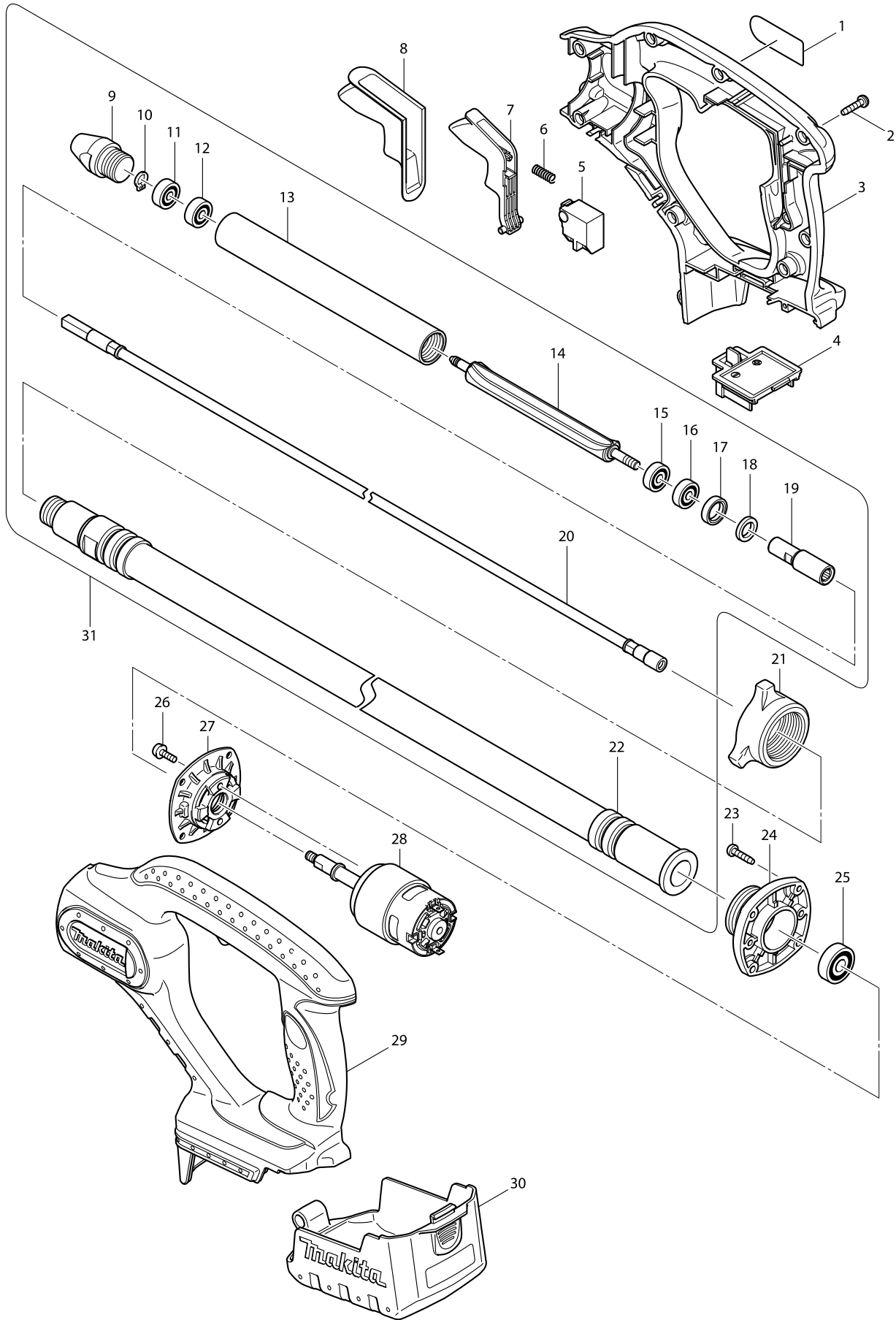

Model No. DVR450 CORDLESS CONCRETE VIBRATOR

Item	Parts No.	Description	I/C	Qty	N/O	Opt. 1	Opt. 2	Note
001	850D48-4	DVR450 NAME PLATE		1				
002	266045-0	TAPPING SCREW 4X20		9				
003	187867-4	HOUSING SET		1				
D10		INC. 29						
004	643843-3	TERMINAL		1				
005	650580-2	SWITCH SGE120C-4		1				
006	231298-0	COMPRESSION SPRING 6		1				
007	419511-8	SWITCH LEVER		1				
008	421961-5	WATERPROOF COVER		1				
009	322935-8	CAP		1				
010	961002-0	RETAINING RING S-6		1				
011	210018-5	BALL BEARING 626		1				
012	210018-5	BALL BEARING 626		1				
013	331503-6	PIPE 25		1				
014	322934-0	UNBALANCER		1				
015	211016-2	BALL BEARING 626LLB		1				
016	211016-2	BALL BEARING 626LLB		1				
017	421578-4	RUBBER RING		1				
018	443101-5	FELT RING		1				
019	326203-1	JOINT		1				
020	163534-5	FLEXIBLE WIRE		1				
021	416244-6	NUT 36		1				
022	163537-9	FLEXIBLE HOSE		1				
023	266045-0	TAPPING SCREW 4X20		4				
024	316893-8	BEARING BOX		1				
025	211056-0	BALL BEARING 629LLB		1				
026	911118-1	PAN HEAD SCREW M4X12		2				
027	318867-5	SUPPORTER		1				
028	629947-5	DC MOTOR		1				
029	187867-4	HOUSING SET		1				
D10		INC. 3						
030	158051-8	COVER COMPLETE		1				
C10	810196-7	CAUTION LABEL		1				
031	126206-3	FLEXIBLE ASSEMBLY		1				
D10		INC. 9-20,22						
A01C	***DC18RC	DC18RC FAST CHARGER		1				
A02C	194204-5	BATTERY BL1830 SET		2	*			
A02-1C	194204-5	BATTERY BL1830 SET	O	2				
A03C	141481-0	PLASTIC CARRYING CASE		1				
C10	417383-5	LATCH		2				
A04C	450128-8	BATTERY COVER		1				
E01	688161-2	LINE FILTER		1				
E02	688172-7	LINE FILTER		1				